



Product information ELWIKA 5012 PG7

Industrial Connecting Solutions: Circular Connectors: M8 - M12 Connectors: M12 Connectors: M12 Circular connector (M12 E-Series): with screw locking: Angled cable socket, self-assembled: ELWIKA 5012

PG7

<https://catalog.beldensolutions.com:443/link/57078-24228-256281-256292-256304-24445-24446-24262-36390/en/conf/uistate>

Name	ELWIKA 5012 PG7
	Angled cable socket, unassembled, strain relief by means of clamping cage
Delivery informations	
Availability	available
Product description	
Description	Angled cable socket, unassembled, strain relief by means of clamping cage
Type	ELWIKA 5012 PG7
Order No.	933 175-100
Type of contact	female
Number of contacts	5
Cable gland	PG 7
Standard	IEC 61076-2-101 (Ed. 1)/ IEC 60947-5-2
Housing Color	black
Technical data	
Rated voltage	AC/DC 50 V
Rated current	4 A
Type of termination	screw
Suitable cables	diameter 4 mm to 6 mm, max. 0.75 mm ²
Material	
Contact material	Cu Zn
Contact surface material	Sn
Contact bearer material	PA
Housing material	PA
Coupling nut material	Zn Al/Ni
O-Ring	NBR
Environmental conditions	
Protection class (IEC 60529)	IP 67
Pollution severity	3
Temperature range	-25 °C to +90 °C
Inflammability class	
Housing	94 V-2
Contact bearer	94 V-2
Packing unit	
Packaging unit	100 pieces
Scope of delivery and accessories	
Accessories to order separately	protective cap M12 VS, order no. 734 209-100



HIRSCHMANN

A BELDEN BRAND

Industrial Connecting Solutions: Circular Connectors: M8 - M12 Connectors: M12 Connectors: M12 Circular connector (M12 E-Series)-with screw locking: Angled cable socket, self-assembled: ELWIKA 5012

PG7

<https://catalog.beldensolutions.com:443/link/57078-24228-256281-256292-256304-24445-24446-24262-36390/en/conf/ui/state>

Picture

Drawing

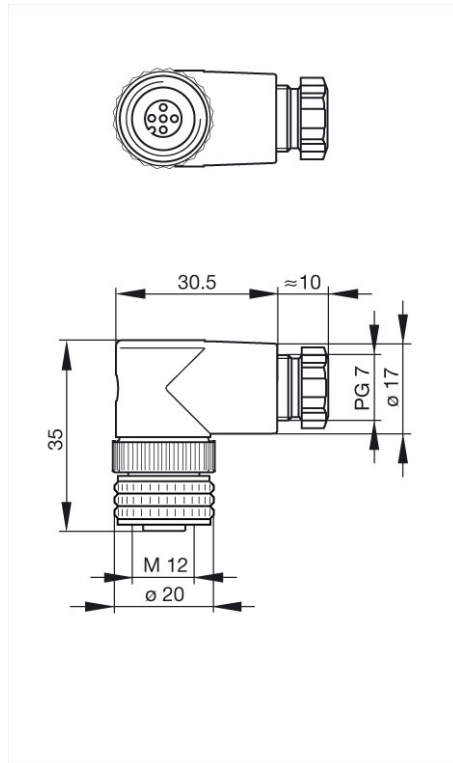

Belden Deutschland GmbH

Im Gewerbepark 2
58579 Schalksmühle
Germany
Phone: +49 7127/14-1806
E-Mail: icos-sales@belden.com

The information published in the websites has been compiled as carefully as possible. It is subject to alteration without notice in technical as well as in price-related/commercial respect. The complete information and data were available on user documentation. Mandatory information can only be obtained by a concrete query.